



Project _____

Item No. _____

Quantity _____

i3™

THE i3™



PERFORMANCE

Utilizing TurboChef's patented technology to rapidly cook food without compromising quality, the i3 oven provides superior cooking performance while requiring less space and consuming less energy.

VENTILATION

- UL (KNLZ) listed for ventless operation.†
- EPA 202 test (8 hr):
 - Product: Pepperoni Pizzas
 - Results: 0.32 mg/m³
 - Ventless Requirement: <5.00 mg/m³
- Internal catalytic filtration to limit smoke, grease, and odor emissions.

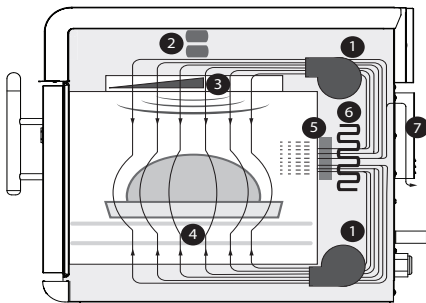

1. Blower Motors
2. Microwave System
3. Stirred Impinged Air (Top) and Microwave
4. Impinged Air (Bottom)
5. Catalytic Converter
6. Impingement Heater
7. Vent Tube Catalyst

EXTERIOR CONSTRUCTION

- Two-tone stainless steel front, top and sides
- 304 stainless steel removable grease collection pan
- Ergonomic door handle
- Rubber seal for surface mounting
- Side hand grips for lifting

INTERIOR CONSTRUCTION

- 304 stainless steel
- Fully insulated cook chamber
- Removable rack
- Top and bottom jetplates

STANDARD FEATURES

- Integral recirculating catalytic converter for UL (KNLZ) listed ventless operation
- Independently-controlled dual motors for vertically-recirculated air impingement
- Top-launched microwave system
- Stirrer to help ensure even distribution of air and microwave
- External air filtration
- Smart menu system capable of storing up to 200 recipes
- Flash software updates via smart card
- Single or multiple-temperature interface
- Smart Voltage Sensor Technology* (U.S. only)
- Vent catalyst to further limit emissions
- Built-in self-diagnostics for monitoring oven components and performance
- Stackable (requires stacking stand)
- Field-configurable for single or 3-phase operation
- Includes plug and cord (6 ft. nominal)
- Warranty – 1 year parts and labor

COMES WITH STANDARD ACCESSORIES

- 1 Aluminum Paddle (NGC-1478)
- 1 Bottle Oven Cleaner (103180)
- 1 Bottle Oven Guard (103181)
- 2 Trigger Sprayers (103182)
- 2 PTFE Baskets (NGC-1331)



This product conforms to the ventilation recommendations set forth by NFPA96 using EPA202 test method.

* Smart Voltage Sensor Technology does not compensate for lack of or over voltage situations. It is the responsibility of the owner to supply voltage to the unit according to the specifications on the back of this sheet.

† Ventless certification is for all food items except for foods classified as "fatty raw proteins." Such foods include bone-in, skin-on chicken, raw hamburger meat, raw bacon, raw sausage, steaks, etc. If cooking these types of foods, consult local HVAC codes and authorities to ensure compliance with ventilation requirements.

Ultimate ventless allowance is dependent upon AHJ approval, as some jurisdictions may not recognize the UL certification or application. If you have questions regarding ventless certifications or local codes please email ventless.help@turbochef.com

TurboChef reserves the right to make substitutions of components or change specifications without prior notice.

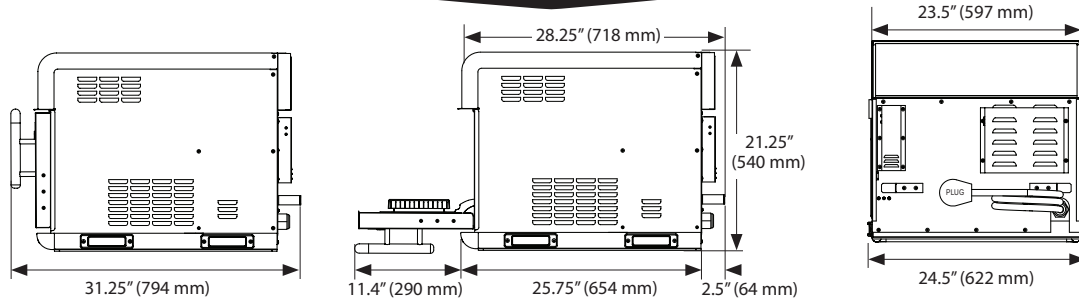

DIMENSIONS		
Single Units		
Height	21.25"	540 mm
Width	24.5"	622 mm
Depth	31.25"	794 mm
Weight	245 lb.	111 kg
Cook Chamber		
Height	6.9"	175 mm
Width	19.4"	493 mm
Depth (Door Open / Closed)	14.75" / 12.75"	375 mm / 324 mm
Volume	1.14 cu.ft.	32.3 liters
Wall Clearance (Oven not intended for built-in installation)		
Top	19"	483 mm
Sides	2"	51 mm
ELECTRICAL SPECIFICATIONS-SINGLE PHASE		
i3 US Model (i3-9500-1) - United States		
Voltage	208/240 VAC	
Frequency	60 Hz	
Current (Max Circuit Requirement)	40 amp (40 amp)	
Max Input	8300/9600 watts	
i3 UK Model (i3-9500-2-U) - United Kingdom		
Voltage	230 VAC	
Frequency	50 Hz	
Current (Max Circuit Requirement)	40 amp (62 amp)	
Max Input	9200 watts	
i3 BK Model (i3-9500-6-BK) - Brazil		
Voltage	220 VAC	
Frequency	60 Hz	
Current (Max Circuit Requirement)	40 amp (50 amp)	
Max Input	8800 watts	
i3 LA Model (i3-9500-7-LA) - Latin America		
Voltage	220 VAC	
Frequency	60 Hz	
Current (Max Circuit Requirement)	40 amp (50 amp)	
Max Input	8800 watts	
i3 JK Model - 50 Hz (i3-9500-8-JK) - Japan 60 Hz (i3-9500-10-JK) - Japan		
Voltage	200 VAC	
Frequency	50 Hz or 60 Hz	
Current (Max Circuit Requirement)	40 amp (40 amp)	
Max Input	8000 watts	
ELECTRICAL SPECIFICATIONS-MULTI PHASE		
i3 DL Model (i3-9500-14-DL) - United States		
Voltage	208/240 VAC	
Frequency	60 Hz	
Current (Max Circuit Requirement)	24 amp (30 amp)	
Max Input	8600/9900 watts	

i3 ED Model (i3-9500-3-ED) - International		
Voltage	230 VAC	
Frequency	50 Hz	
Current (Max Circuit Requirement)	24 amp (32 amp)	
Max Input	9500 watts	
i3 EW Model (i3-9500-4-EW) - International		
Voltage	400 VAC	
Frequency	50 Hz	
Current (Max Circuit Requirement)	14 amp (20 amp)	
Max Input	9500 watts	
i3 AU Model (i3-9500-5-AU) - Australia		
Voltage	400 VAC	
Frequency	50 Hz	
Current (Max Circuit Requirement)	14 amp (20 amp)	
Max Input	9500 watts	
i3 JD Model - 50 Hz (i3-9500-9-JD) - Japan 60 Hz (i3-9500-11-JD) - Japan		
Voltage	200 VAC	
Frequency	50 Hz or 60 Hz	
Current (Max Circuit Requirement)	23 amp (30 amp)	
Max Input	8000 watts	
i3 KW Model (i3-9500-12-KW) - Middle East & Korea		
Voltage	400 VAC	
Frequency	60 Hz	
Current (Max Circuit Requirement)	14 amp (20 amp)	
Max Input	9500 watts	
i3 SD Model (i3-9500-13-SD) - Middle East & Korea		
Voltage	230 VAC	
Frequency	60 Hz	
Current (Max Circuit Requirement)	24 amp (30 amp)	
Max Input	9200 watts	
i3 LD Model (i3-9500-15-LD) - Latin America		
Voltage	220 VAC	
Frequency	60 Hz	
Current (Max Circuit Requirement)	24 amp (30 amp)	
Max Input	9100 watts	
i3 BD Model (i3-9500-16-BD) - Brazil		
Voltage	220 VAC	
Frequency	60 Hz	
Current (Max Circuit Requirement)	24 amp (30 amp)	
Max Input	9100 watts	
SHIPPING INFORMATION		
U.S.: All ovens shipped within the U.S. are packaged in a double-wall corrugated box banded to a wooden skid. International: All International ovens shipped via Air or Less than Container Loads are packaged in wooden crates.		
Box size: 34" (L) x 30" (W) x 32" (H) / 864 mm x 762 mm x 813 mm Crate size: 37" (L) x 33" (W) x 34" (H) / 940 mm x 838 mm x 864 mm Item class: 110 NMFC #26710 HS code 8419.81		
Boxed weight: 290 lb. (132 kg) Crated weight: 365 lb. (166 kg)		
Minimum entry clearance required for box: 30.5" (775 mm) Minimum entry clearance required for crate: 33.5" (851 mm)		

TurboChef recommends installing a type D circuit breaker for European installations.
TurboChef reserves the right to substitute components or change specifications without notice.
© 2009-2017 TurboChef Technologies, Inc.